

Desigo™ Control Point

## BACnet/IP Web interface

PXG3.W100-2, PXG3.W200-2



**Interface for web-based, graphical operation of BACnet automation stations using Desigo touch panels and devices with an HTML 5.0 web browser.**

- Simultaneous access by various operator units
- Central administration of graphics and data for other operating views
- Offline engineering with ABT Site
- Upload and download configuration data over the IP interface
- 2-port Ethernet switch for low-cost cabling (10Base-T/100Base-Tx)
- LED indication for Ethernet link and activity
- Operating voltage AC 24 V or DC 24 V
- Plug-in screw terminal block for supply
- Mounting on DIN rail or on the wall
- Building X integration
- BACnet Secure Connect communication as BACnet/SC node

## Functions

The device has a web server that processes data from various Desigo automation stations and other devices based on BACnet IP to HTML5 web pages.

The following functions are available to operate and monitor a plant:

- Log-in and log-out
- User administration
- Customized graphics
- Alarm view to monitor and log alarms
- Alarm forwarding to e-mail recipient
- Graphics-based operation of time schedules
- Graphically displaying trend data
- Generic operation of all objects and properties of assigned devices
- Cloud connectivity to Building X for remote access
- BTL tested BACnet communication, in compliance with BACnet standard including B-OD profile (Rev. 1.16). IT security including HTTPS and BACnet Secure Connect. BACnet Secure Connect support as BACnet/SC node.

## Application

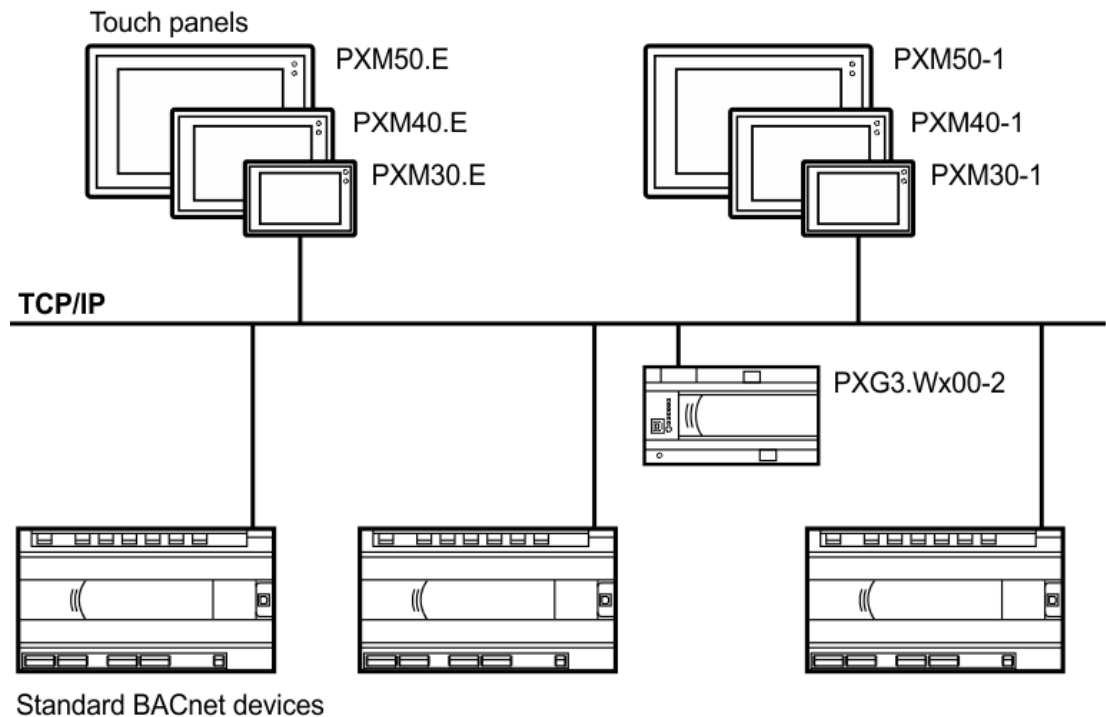

The web interfaces PXG3.W100-2 and PXG3.W200-2 are the central points of access to operate the automation level and room automation. The central point of access permits simultaneous operation on various operator units and supports

- Connection of Desigo touch panels PXM30-1, PXM40-1 und PXM50-1
- Access via devices using a standard web browser with HTML5.

## Type summary

Type	Order number	Description
PXG3.W100-2	S55842-Z140	BACnet/IP web interface with standard functionality
PXG3.W200-2	S55842-Z141	BACnet/IP web interface with extended functionality

Type of document	Document no.
Data sheet BACnet/IP Touch Panels PXM30.E / PXM40.E / PXM50.E	A6V11664137
Data sheet Touch Panel Clients PXM30-1 / PXM40-1 / PXM50-1	A6V11664139
Desigo Control Point Basic documentation	A6V11666339
Desigo Touch-Panel Clients Commissioning	A6V11604303
Desigo Control Point Operating manual	A6V11211557
Desigo Control Point Engineering manual	A6V11604297

Related documents such as the environmental declarations, declarations of conformity, etc., can be downloaded from the following Internet address:



[www.siemens.com/bt/download](http://www.siemens.com/bt/download)

Technical and mechanical design

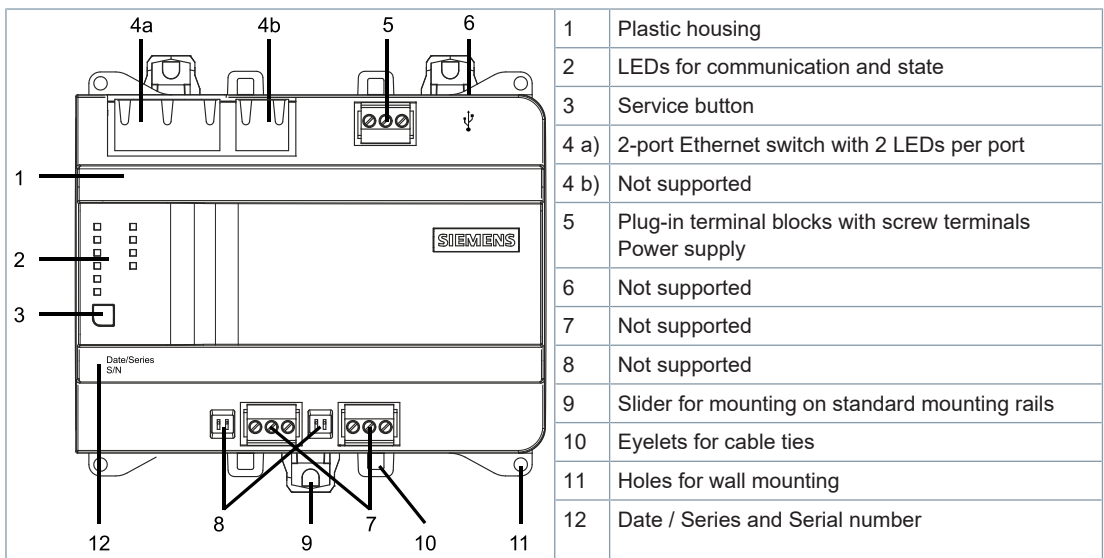
The device can be mounted on a standard rail or on the wall.

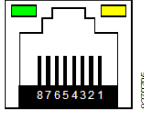
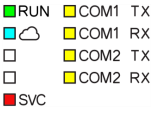
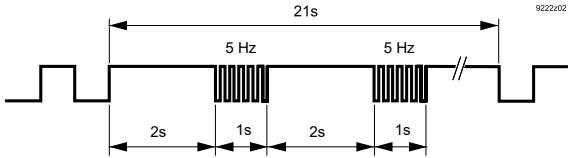

## LED indicators and service pin

Activity	LED / Interface	Color	Activity	Function	
 	Ethernet 1...2	Green	Continuously ON Continuously OFF Flashing	Link active No connection Network traffic	
		Yellow	Continuously ON Continuously OFF	Link 100 Mbps Link 10 Mbps	
	RUN	Green	Continuously ON Continuously OFF Flashing	Device operational Device not operational Start-up or program halted	
			Red	Continuously OFF Continuously ON  Rapid flashing	OK HW or SW fault - power off and on the device Firmware or application missing/corrupted
		Cloud icon	Blue	Steady ON Blinking  Steady OFF	Cloud connection OK Cloud connection enabled but no connection available Cloud connection disabled
	SVC	Red	Continuously OFF Flashing	OK Device is not configured	
			Flashing per wink command	Identification of the device after receipt of wink command	
					
	COM1 / 2 TX	Yellow	Continuously OFF	Function not supported	
	COM1 / 2 RX	Yellow	Continuously OFF	Function not supported	
 SVC	Service button		Short press	Identification on the network	
			As per description:	Do the following to reset the device to factory state: <ol style="list-style-type: none"> <li>1. Power off the device.</li> <li>2. Power on the device.</li> <li>3. Wait until all LEDs light up and turn off again, then press the Service button.</li> <li>4. Keep the Service button pressed until all LEDs light up, then release the button. All LEDs turn off, the device restarts.</li> <li>5. Wait until the device has fully started up – unconfigured (green RUN LED and red SVC LED are flashing).</li> </ol>	

## Safety

**⚠ CAUTION****National safety regulations**

Failure to comply with national safety regulations may result in personal injury and property damage.

- Observe national provisions and comply with the appropriate safety regulations.

**Mounting position and ambient temperature**

The devices can be snapped onto standard rails or screwed onto a flat surface.  
Plug-in screw terminals connect power and interfaces (except for Ethernet).

Ambient temperature -5...50 °C (23...122 °F)	Ambient temperature -5...45 °C (23...113 °F)
<ul style="list-style-type: none"> <li>• Wall, horizontal               <ul style="list-style-type: none"> <li>– From left to right</li> <li>– From right to left</li> </ul> </li> </ul>	<ul style="list-style-type: none"> <li>• Overhead</li> <li>• Wall, vertically               <ul style="list-style-type: none"> <li>– From top to bottom</li> <li>– From bottom to top</li> </ul> </li> <li>• On a horizontal surface</li> </ul>

**⚠ CAUTION****Risk of overheating for failure to comply with ambient temperature**

Burning and damage to the device

- Ensure sufficient ventilation to comply with the permissible ambient temperature within the panel or installation box. The temperature must be at least 10 K (18° F) lower outside the installation box.

## Installation

**⚠ WARNING****Electric shock**

Incorrect installation of the device may lead to electric shock injuries when touching the device!

- Install the device in a lockable cabinet or use terminal covers.
- Do not install the device in locations where children are likely to be present.
- Conductors with a cross-section of 0.5 mm<sup>2</sup> (AWG24) or greater shall comply with the requirements of IEC 60332-1-2 and IEC 60332-1-3 or IEC TS 60695-11-21.

## Disposal



The device is considered an electronic device for disposal in accordance with European Directive and may not be disposed of as domestic waste.

- Use only designated channels for disposing the devices.
- Comply with all local and currently applicable laws and regulations.

## Technical data

### Power supply

Operating voltage 24 V AC (24 V $\approx$ , $\perp$ , $\text{⏚}$ )	AC 24 V -15 / +20 % (PELV) AC 24 V Class 2 (US) 48...63 Hz
Operating voltage 24 V DC	DC 24 V -15 / +20 % (PELV) DC 24 V Class 2 (US)
Functional ground (US) Functional earth $\text{⏚}$	The terminal for the functional ground must be connected on the installation side with the building grounding system (PE).
Screw terminals for wire cross sections up to	Max. 2.5 mm <sup>2</sup> (14 AWG)
Internal fusing	2.5 A irreversible / non-replaceable
External supply line fusing (EU)	Non-renewable fuse max. 10 A slow or circuit breaker max. 13 A Tripping characteristic B, C, D per EN 60898 or Power supply with current limitation of max. 10 A

### Power consumption (for transformer planning)

Power consumption AC	
Base load	10 VA
With USB (not supported)	16 VA
Power consumption DC	
Base load	5 W
With USB (not supported)	8 W

### Function data

Hardware information	
Processor	NXP i.MX8 DualX, 1 GHz
Storage	2 GB RAM 8 GB eMMC

Real-time clock	
Energy reserve (Supercap) to support real-time clock (7 days).	

### Interfaces

Ethernet interface	
Plug	2 x RJ45, shielded
Interface type	10Base-T / 100Base-TX, IEEE 802.3 compatible
Bit rate	10/100 Mbps, autosensing
Protocol	BACnet/IP on UDP/IP, BACnet/SC on TCP/IP, and HTTPS on TCP/IP
Cabling, cable type	10 Mbps: Min. CAT3, shielded cable is recommended 100 Mbps: Min. CAT5, shielded cable is recommended
Cable length	Max. 100 m (330 ft)

Screw terminals, plug-in	
Cu-wire or Cu-strand with wire end sleeve	1 x 0.6 mm $\emptyset$ to 2.5 mm <sup>2</sup> (22 to 14 AWG) or 2 x 0.6 mm $\emptyset$ to 1.0 mm <sup>2</sup> (22 to 18 AWG)
Cu-strand without wire end sleeve	1 x 0.6 mm $\emptyset$ to 2.5 mm <sup>2</sup> (22 to 14 AWG) or 2 x 0.6 mm $\emptyset$ to 1.5 mm <sup>2</sup> (22 to 16 AWG)
Stripping length	6...7.5 mm (0.24...0.29 in)
Screwdriver	Slot screws, screwdriver size 1 with shaft $\emptyset$ = 3 mm
Max. tightening torque	0.6 Nm (0.44 lb ft)

## Conformity

Ambient conditions and protection classification	
Classification as per EN 60730	Type 1
Automatic action	Class A
Control function	2
Degree of pollution	I
Overvoltage category	I
Protection against electric shock	Protection class III
Degree of protection of housing to EN 60529	IP30
Front parts in DIN cut-out	IP20
Terminal part	IP20
Climatic ambient conditions	<ul style="list-style-type: none"> <li>• Storage / Transport (packaged for transport) as per IEC EN 60721-3-1 / IEC EN 60721-3-2</li> <li>• Operation as per IEC/EN 60721-3-3</li> </ul>
	<ul style="list-style-type: none"> <li>• Class 1K22 / 2K12 Temperature -25...70 °C (-13...158 °F) Air humidity 5...95 % (non-condensing)</li> <li>• Class 3K23 Operation in enclosed dry locations, having no temperature or humidity control Temperature -5...50 °C (23...122 °F) (for details see chapter Mounting) Air humidity 5...95 % (non-condensing)</li> </ul>
Mechanical ambient conditions	<ul style="list-style-type: none"> <li>• Transport per IEC/EN 60721-3-2</li> <li>• Operation as per IEC/EN 60721-3-3</li> </ul>
	<ul style="list-style-type: none"> <li>• Class 2M4</li> <li>• Class 3M11</li> </ul>

Standards, directives and approvals	
Product standards	IEC/EN 60730-1 and IEC/EN 62368-1
Product family standard	IEC/EN 63044-x
Electromagnetic compatibility (EMC)	For residential, commercial, and industrial environments
EU conformity (CE)	See CE declaration <sup>1)</sup>
EAC compliance	Eurasian compliance
RCM conformity	See RCM declaration <sup>1)</sup>
UL/cUL certification (US / Canada)	UL916; <a href="http://ul.com/database">http://ul.com/database</a>
CSA certification	C22.2, <a href="http://csagroup.org/services-industries/product-listing">http://csagroup.org/services-industries/product-listing</a>
FCC	CFR 47 Part 15B
BACnet	Profile: B-OD Revision: 1.16 Detailed information on BACnet certificates, BTL listings, and PICS can be found on the BACnet website ( <a href="#">filtered for Siemens products</a> )
Environmental compatibility <sup>1)</sup>	The product environmental declaration <sup>1)</sup> contains data on environmentally compatible product design and assessments (RoHS compliance, materials composition, packaging, environmental benefit, disposal).

<sup>1)</sup> Documents can be downloaded at <http://siemens.com/bt/download>.

## European Union conformity

Contact for regulatory topics: (EU) Siemens AG, Berliner Ring 23, DE-76437 Rastatt

## FCC Statement

This equipment has been tested and found to comply with the limits for a Class B digital device, pursuant to part 15 of the FCC Rules. These limits are designed to provide reasonable protection against harmful interference in a residential installation. This equipment generates, uses and can radiate radio frequency energy and, if not installed and used in accordance with the instructions, may cause harmful interference to radio communications. However, there is no guarantee that interference will not occur in a particular installation. If this equipment does cause harmful interference to radio or television reception, which can be determined by turning the equipment off and on, the user is encouraged to try to correct the interference by one or more of the following measures:

- Reorient or relocate the receiving antenna.
- Increase the separation between the equipment and receiver.
- Connect the equipment into an outlet on a circuit different from that to which the receiver is connected.
- Consult the dealer or an experienced radio/TV technician for help.

This device complies with Part 15 of the FCC rules. Operation is subject to the following two conditions:

1. This device may not cause harmful interference, and
2. this device must accept any interference received, including interference that may cause undesired operation

**FCC Caution:** Changes or modifications not expressly approved by Siemens Switzerland Ltd. could void user authority to operate the equipment. United States representative <https://new.siemens.com/us/en/products/buildingtechnologies/home.html>



### Industry Canada statement

This device complies with ISED's license-exempt RSSs. Operation is subject to the following two conditions:

1. This device may not cause interference, and
2. This device must accept any interference received, including interference that may cause undesired operation.

### Housing

---

Color top/bottom	2003 Ti-Grey / 804 Black
Dimensions	per DIN 43 880, see dimensions
Weight with/without packaging	350 g / 300 g

## Connection terminals

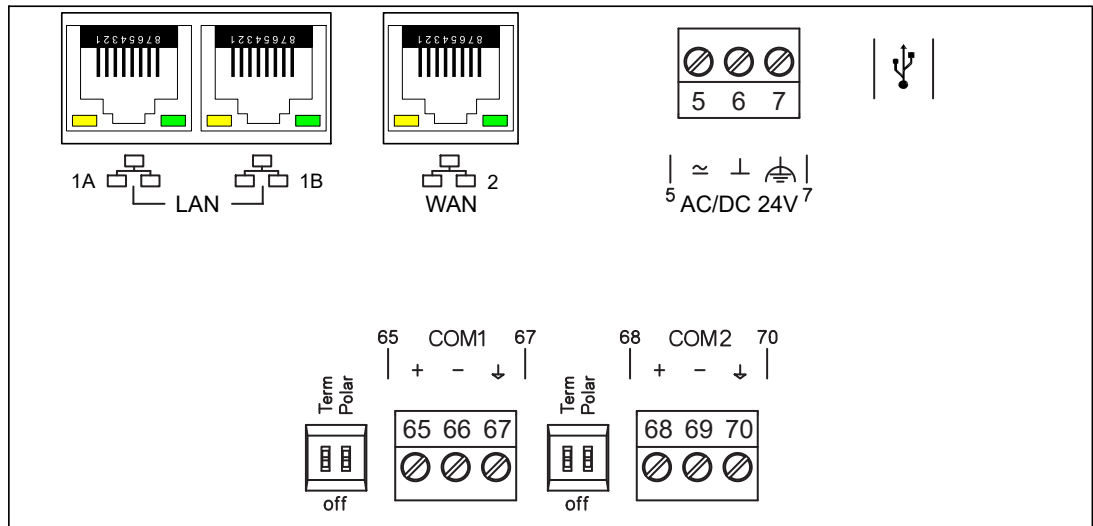

Terminal	Symbol	Description
1A, 1B		2 x RJ45 interface for Ethernet with switch LAN (customer network)
2		Not supported
5, 6	≈, ⊥,	Operating voltage AC 24 V, DC 24 V
7		Functional ground (must be connected on the installation side with the building grounding system (PE).
USB		Not supported
Term	off	Not supported
Polar	off	Not supported
65, 66, 67	COM1	Not supported
68, 69, 70	COM2	

## Dimensions

All dimensions in mm and inches

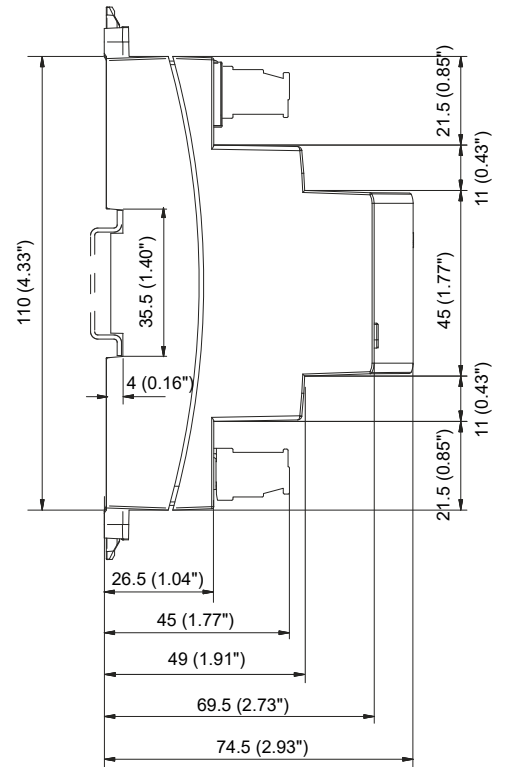
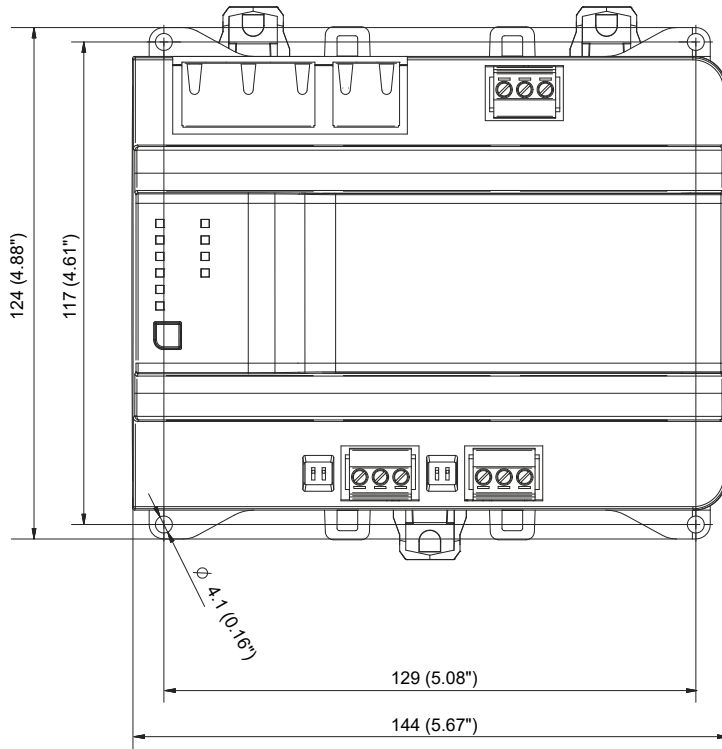

Issued by  
Siemens Switzerland Ltd  
Smart Infrastructure  
Global Headquarters  
Theilerstrasse 1a  
CH-6300 Zug  
+41 58 724 2424  
[www.siemens.com/buildingtechnologies](http://www.siemens.com/buildingtechnologies)

© Siemens 2021  
Technical specifications and availability subject to change without notice.

---

Document ID    A6V12304192\_en--\_f  
Edition        2024-02-28