

Driver LC 35W 500-800mA flexC SC ADV

advanced series

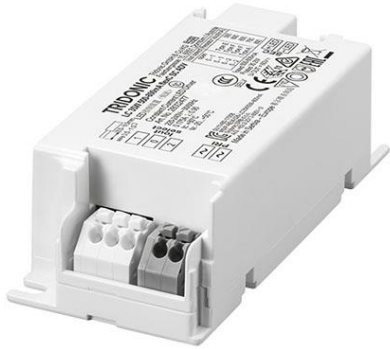

With strain-relief (see accessory)

Product description

- _ Can be either used built-in or independent with clip-on strain-relief (see accessory)
- _ Small design (97 x 43 x 30 mm)
- _ Constant current LED driver
- _ For luminaires of protection class I and protection class II
- _ Temperature protection as per EN 61347-2-13 C5e
- _ Adjustable output current between 500 and 800 mA, in 5 steps with ADV plug technology (pre-selected current 500 mA)
- _ Max. output power 35.2 W
- _ Nominal lifetime up to 100,000 h
- _ 5 years guarantee (conditions at <https://www.tridonic.com/manufacture-guarantee-conditions>)

Housing properties

- _ Casing: polycarbonate, white
- _ Type of protection IP20

Functions

- _ Overtemperature protection
- _ Overload protection
- _ Short-circuit protection
- _ No-load protection
- _ Burst protection voltage 1 kV
- _ Surge protection voltage 1 kV (L to N)
- _ Surge protection voltage 2 kV (L/N to earth)

Typical applications

- _ For spot light and downlight in retail and hospitality applications
- _ For panel light and area light in office and education application

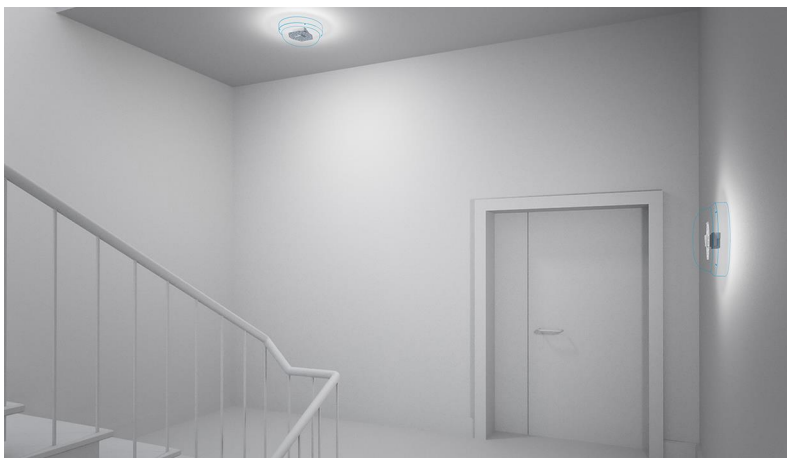
Website<http://www.tridonic.com/28002477>

Spotlights



Downlights



Linear



Area



Floor | Wall



Free-standing



Street



Decorative



High bay

Driver LC 35W 500-800mA flexC SC ADV

advanced series

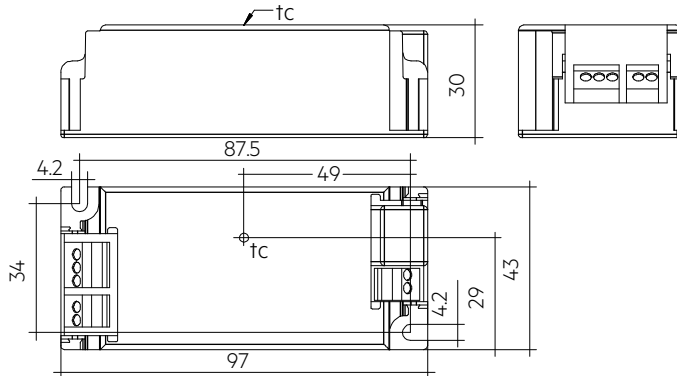

Ordering data

Type	Article number	Packaging, carton	Packaging, pallet	Weight per pc.
LC 35W 500-800mA flexC SC ADV	28002477	15 pc(s).	1,665 pc(s).	0.1 kg

Technical data

Rated supply voltage	220 – 240 V
AC voltage range	198 – 264 V
Max. input current (at 230 V, 50 Hz, full load) ^①	0.175 A
Mains frequency	50 / 60 Hz
Overvoltage protection	320 V AC, 1 h
Max. input power	42 W
Typ. power consumption (at 230 V, 50 Hz, full load) ^②	39.1 W
Min. output power	12.5 W
Max. output power	35 W
Typ. efficiency (at 230 V, 50 Hz, full load) ^②	88 %
λ (at 230 V, 50 Hz, full load) ^②	0.95
Output current tolerance ^③	± 7.5 %
Max. output current peak	\leq output current + 12.5 %
Max. output voltage (U-OUT)	60 V
THD (at 230 V, 50 Hz, full load) ^②	< 10 %
Output LF current ripple (< 120 Hz)	± 5 %
Output P_ST_LM (at full load)	≤ 1
Output SVM (at full load)	≤ 0.4
Starting time (at 230 V, 50 Hz, full load)	≤ 0.5 s
Turn off time (at 230 V, 50 Hz, full load)	≤ 0.5 s
Hold on time at power failure (output)	0 s
Ambient temperature t_a (at lifetime 50,000 h)	50 °C
Storage temperature t_s	-40 ... +80 °C
Lifetime	up to 100,000 h
Guarantee (conditions at www.tridonic.com)	5 Year(s)
Dimensions L x W x H	97 x 43 x 30 mm

Approval marks



Standards

EN 55015, EN 61000-3-2, EN 61000-3-3, EN 61347-1, EN 61347-2-13, EN 61547, EN 62384

Specific technical data

Type	Output current ^③	Min. output voltage	Max. output voltage	Max. output power	Typ. power consumption (at 230 V, 50 Hz, full load)	Typ. current consumption (at 230 V, 50 Hz, full load)	tc point max.	Ambient temperature T _a	Iout select	Resistor ^④
LC 35W 500-800mA flexC SC ADV	500 mA	25 V	42 V	21.0 W	22.8 W	112 mA	80 °C	-20 ... +50 °C	-	-
LC 35W 500-800mA flexC SC ADV	600 mA	25 V	42 V	25.2 W	27.7 W	127 mA	80 °C	-20 ... +50 °C	0-1	ADV Type E
LC 35W 500-800mA flexC SC ADV	650 mA	25 V	44 V	28.6 W	31.5 W	143 mA	80 °C	-20 ... +50 °C	0-1	ADV Type F
LC 35W 500-800mA flexC SC ADV	700 mA	25 V	45 V	31.5 W	35.0 W	154 mA	80 °C	-20 ... +50 °C	0-2	ADV Type F
LC 35W 500-800mA flexC SC ADV	800 mA	30 V	44 V	35.2 W	39.1 W	175 mA	80 °C	-20 ... +50 °C	0-2	ADV Type A

① Test result at 25 °C.

② Test result at 800 mA.

③ Output current is mean value.

④ Type A is a short circuit plug (0 Ω).

Strain-relief set 43x30mm

Accessory



Product description

- _ Optional strain-relief set for independent applications
- _ Transforms the LED driver into a fully class II compatible LED driver (e.g. ceiling installation)
- _ Easy and tool-free mounting to the LED driver, screwless cable-clamp channels for long strain-relief (30 x 43 x 30 mm)
- _ With screws for short strain-relief (15 x 34 x 30 mm)
- _ Overall length = length L (LED driver) + 2 x 30 mm (long strain-relief set), 2 x 15 mm (short strain-relief) or long and short strain-relief any combination
- _ Standard SC (L = 30 mm) available as non-pre-assembled and pre-assembled
- _ Short SC (L = 15 mm) only pre-assembled available

Website

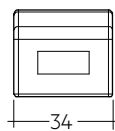
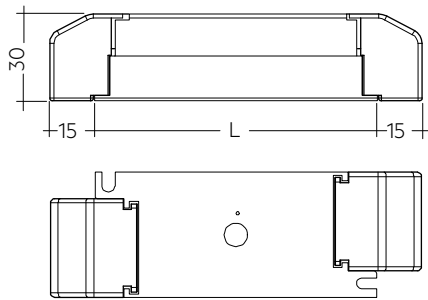
<http://www.tridonic.com/28001168>

Permissible
cable jacket
diameter:
3 – 9 mm

Ordering data

Type	Article number	Packaging, carton ^①	Packaging, outer box	Weight per pc.
ACU SC 43x30mm CLIP-ON SR SET	28001168	10 pc(s).	500 pc(s).	0.038 kg
ACU SC 43x30mm CLIP-ON SR SET 300	28001351	300 pc(s).	300 pc(s).	0.038 kg
ACU SC 30x43x30mm CLIP-ON SR PA	28001699	10 pc(s).	500 pc(s).	0.021 kg
ACU SC 15x43x30mm CLIP-ON SR PA	28001574	10 pc(s).	1,200 pc(s).	0.010 kg

Approval marks



^① 28001168: A carton of 10 pcs. is equal to 10 sets, each with 2 strain-reliefs parts. 28001351: A carton of 300 pcs. is equal to 300 sets, each with 2 strain-reliefs parts. 28001699 + 28001574: A carton contains exactly 10 pcs. strain-reliefs (no sets).

ADV Plug for output current select

Accessory

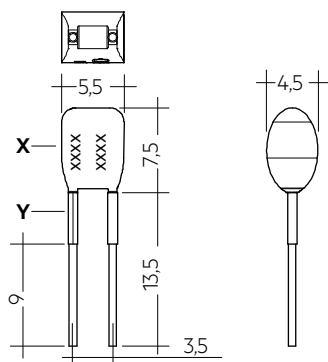

Product description

- _ Ready-for-use resistor to set output current value
- _ Compatible with LED driver serie LC flexC ADV; not compatible with I-SELECT (generation 1) and I-SELECT 2 (generation 2)
- _ Resistor is base insulated
- _ When using your own resistors, make sure the resistor must be isolated
- _ Resistor power 0.25 W
- _ Current tolerance $\pm 2\%$ additional to output current tolerance
- _ Hot plug of the resistor is not permitted
- _ For detailed current setting see table "Specific technical data" of the respective LED driver and chapter 3.7 or 3.8 Current setting in data sheet

Website

<http://www.tridonic.com/28001771>



Ordering data

Type	Article number	Colour of X area	Colour of Y area	Marking	Resistor value	Packaging, bag	Weight per pc.
ADV Plug Type A YL	28001771	Yellow	Yellow	A	0.00 k Ω	10 pc(s).	0.001 kg
ADV Plug Type E YL	28002096	Yellow	Brown	E	0.10 k Ω	10 pc(s).	0.001 kg
ADV Plug Type F YL	28002097	Yellow	Grey	F	0.03 k Ω	10 pc(s).	0.001 kg

1. Standards

EN 55015
 EN 61000-3-2
 EN 61000-3-3
 EN 61347-1
 EN 61347-2-13
 EN 61547
 EN 62384

1.1 Glow-wire test

according to EN 61347-1 with increased temperature of 850 °C passed.

2. Thermal details and lifetime

2.1 Expected lifetime

Expected lifetime

Type	ta	40 °C	50 °C
LC 35W 500-800mA flexC SC ADV	tc	70 °C [Ⓢ]	80 °C [Ⓢ]
	Lifetime	100,000 h	50,000 h

[Ⓢ] Test result at max. output voltage.

The LED Drivers are designed for a lifetime stated above under reference conditions and with a failure probability of less than 10 %.

The relation of tc to ta temperature depends also on the luminaire design. If the measured tc temperature is approx. 5 K below tc max., ta temperature should be checked and eventually critical components (e.g. ELCAP) measured. Detailed information on request.

3. Installation / wiring

3.1 Circuit diagram

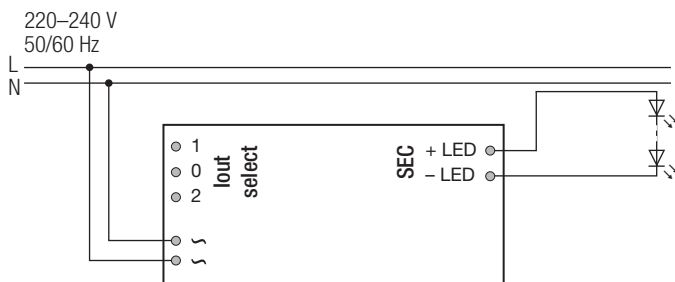

3.2 Wiring type and cross section

The wiring can be in stranded wires with ferrules or solid with a cross section of 0.5–1.5 mm². Strip 8.5–9.5 mm of insulation from the cables to ensure perfect operation of the push-wire terminals. Use one wire for each terminal connector only.

wire preparation:
 0.5 – 1.5 mm²

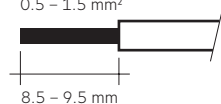

3.3 Release of the wiring

Press down the “push button” and remove the cable from front.

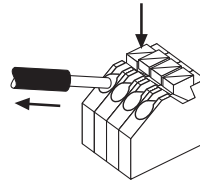

3.4 Fixing conditions when using as independent Driver with Clip-On

Dry, acidfree, oilfree, fatfree. It is not allowed to exceed the maximum ambient temperature (ta) stated on the device. Minimum distances stated below are recommendations and depend on the actual luminaire. Is not suitable for fixing in corner.

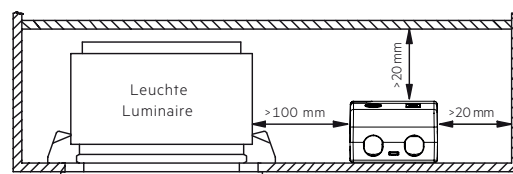

3.5 Wiring guidelines

- All connections must be kept as short as possible to ensure good EMI behaviour.
- Mains leads should be kept apart from LED Driver and other leads (ideally 5 – 10 cm distance)
- Max. length of output wires is 2 m.
- To comply with the EMC regulations run the secondary wires (LED module) in parallel.
- Secondary switching is not permitted.
- Incorrect wiring can damage LED modules.
- To avoid the damage of the Driver, the wiring must be protected against short circuits to earth (sharp edged metal parts, metal cable clips, louver, etc.).

3.6 Replace LED module

1. Mains off
2. Remove LED module
3. Wait for 20 seconds
4. Connect LED module again

Hot plug-in or secondary switching of LEDs is not permitted and may cause a very high current to the LEDs.

3.7 Installation instructions

The LED module and all contact points within the wiring must be sufficiently insulated against 3 kV surge voltage. Air and creepage distance must be maintained.

3.8 Current setting

500 mA: All terminals open

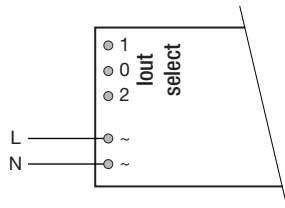

600 mA: Terminal 0 and 1 connected with resistor ADV Plug Type E BR (article number: 28002096)

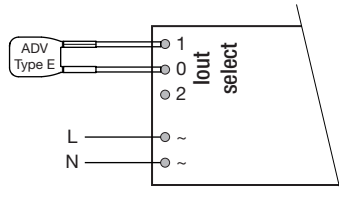

650 mA: Terminal 0 and 1 connected with resistor ADV Plug Type F BR (article number: 28002097)

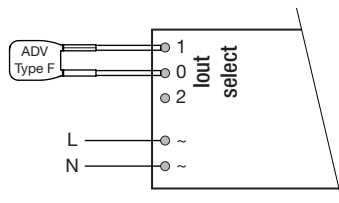

700 mA: Terminal 0 and 2 connected with resistor ADV Plug Type F BR (article number: 28002097)

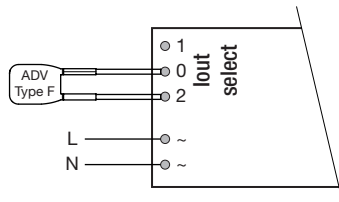

800 mA: Terminal 0 and 2 connected with 0 Ω wire (max. 6 cm length) or resistor ADV Plug Type A BR (article number: 28001771)

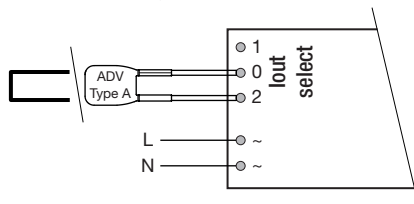

3.9 Mounting of device

Max. torque for fixing: 0.5 Nm/M4

4. Electrical values

4.1 Efficiency vs load

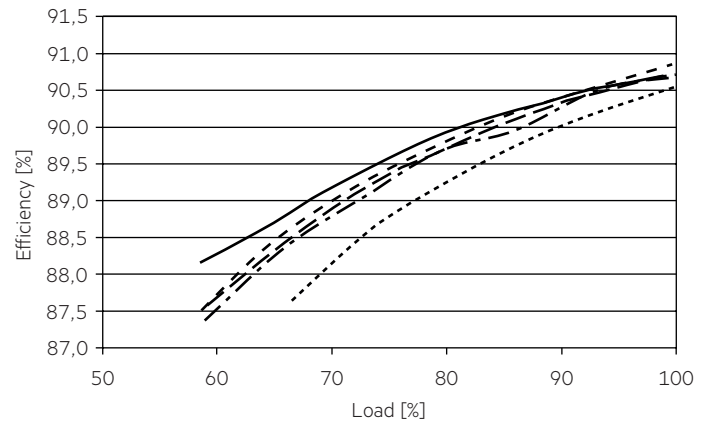

4.2 Power factor vs load

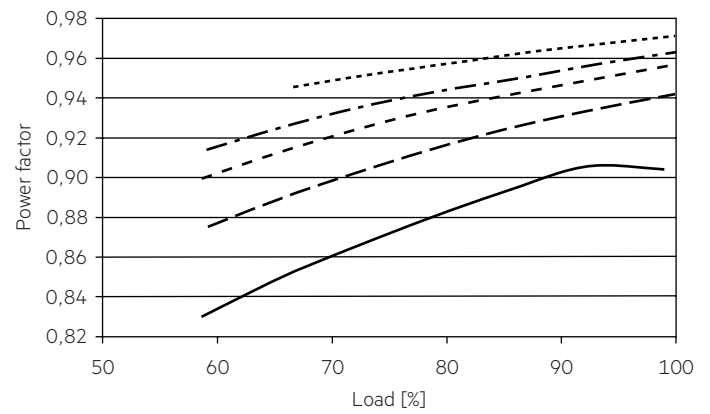

4.3 Input power vs load

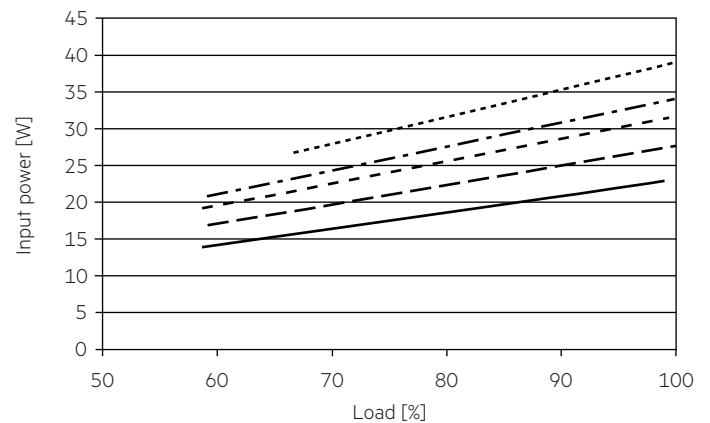

4.4 Input current vs load

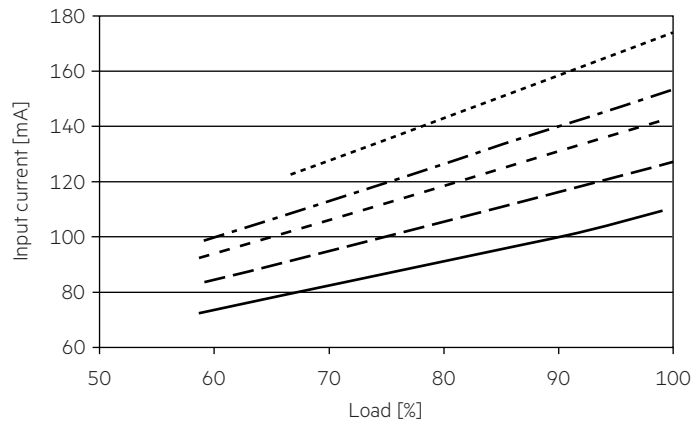

4.5 THD vs load

THD without harmonic < 5 mA (0.6 %) of the input current:

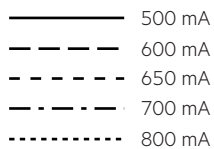
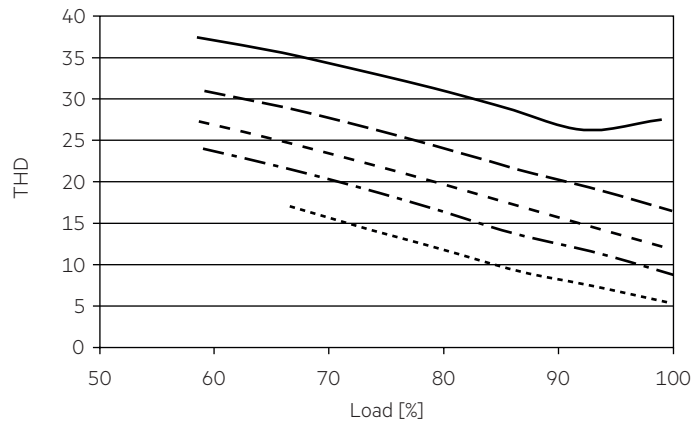

4.6 Maximum loading of automatic circuit breakers in relation to inrush current

Automatic circuit breaker type	C10	C13	C16	C20	B10	B13	B16	B20	Inrush current
Installation Ø	1.5 mm ²	1.5 mm ²	1.5 mm ²	2.5 mm ²	1.5 mm ²	1.5 mm ²	1.5 mm ²	2.5 mm ²	I_{max} Time
LC 35W 500-800mA flexC SC ADV	24	32	40	51	14	19	24	30	25 A 200 µs

This are max. values calculated out of inrush current! Please consider not to exceed the maximum rated continuous current of the circuit breaker. Calculation uses typical values from ABB series S200 as a reference. Actual values may differ due to used circuit breaker types and installation environment.

4.7 Harmonic distortion in the mains supply (at 230 V / 50 Hz and full load) in %

	THD	3.	5.	7.	9.	11.
LC 35W 500-800mA flexC SC ADV	< 10	< 10	< 5	< 4	< 3	< 3

Acc. to 6100-3-2. Harmonics < 5 mA or < 0.6 % (whatever is greater) of the input current are not considered for calculation of THD.

5. Functions

5.1 Short-circuit behaviour

In case of a short circuit on the secondary side (LED) the LED Driver switches off. After elimination of the short-circuit fault the LED Driver will recover automatically.

5.2 No-load operation

The LED Driver works in burst working mode to provide a constant output voltage regulation which allows the application to be able to work safely when LED string opens due to a failure.

5.3 Overload protection

If the maximum load is exceeded by a defined internal limit, the LED Driver will protect itself and LED may flicker. After elimination of the overload the nominal operation will recover automatically.

5.4 Overtemperature protection

The LED Driver is protected against temporary thermal overheating. If the temperature limit is exceeded the LED Driver will switch off. It restarts automatically.

6. Miscellaneous

6.1 Insulation and electric strength testing of luminaires

Electronic devices can be damaged by high voltage. This has to be considered during the routine testing of the luminaires in production.

According to IEC 60598-1 Annex Q (informative only!) or ENEC 303-Annex A, each luminaire should be submitted to an insulation test with 500 V_{DC} for 1 second. This test voltage should be connected between the interconnected phase and neutral terminals and the earth terminal. The insulation resistance must be at least 2 MΩ.

As an alternative, IEC 60598-1 Annex Q describes a test of the electrical strength with 1500 V_{AC} (or 1.414 x 1500 V_{DC}). To avoid damage to the electronic devices this test must not be conducted.

6.2 Conditions of use and storage

Humidity: 5% up to max. 85%,
not condensed
(max. 56 days/year at 85%)

Storage temperature: -40 °C up to max. +80 °C

The devices have to be within the specified temperature range (ta) before they can be operated.

6.3 Maximum number of switching cycles

All LED Driver are tested with 50,000 switching cycles.

6.4 Additional information

Additional technical information at www.tridonic.com → Technical Data

Lifetime declarations are informative and represent no warranty claim. No warranty if device was opened.