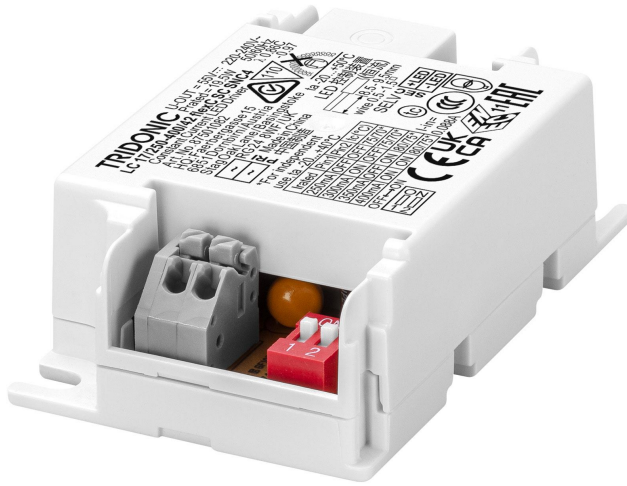

Driver LC 17W 250-400mA flexC SC SNC4

essence series

**Product description**

- _ Fixed output LED driver
- _ Can be either used built-in or independent with clip-on strain-relief (see accessory)
- _ Independent LED driver with cable clamps
- _ For luminaires of protection class I and protection class II
- _ Temperature protection as per EN 61347-2-13 C5e
- _ Constant current LED driver
- _ Selectable fixed output current via DIP switch 250, 300, 350 and 400 mA (pre-selected current 250 mA)
- _ Max. output power 16.8 W
- _ Nominal lifetime up to 100,000 h
- _ 5 years guarantee (conditions at <https://www.tridonic.com/manufacturer-guarantee-conditions>)

Housing properties

- _ Casing: polycarbonate, white
- _ Type of protection IP20

Functions

- _ Overload protection
- _ Short-circuit protection
- _ No-load protection

Typical applications

- _ For spot light and downlight in retail and hospitality applications
- _ For panel light and area light in office and education application

Website

<http://www.tridonic.com/87501082>

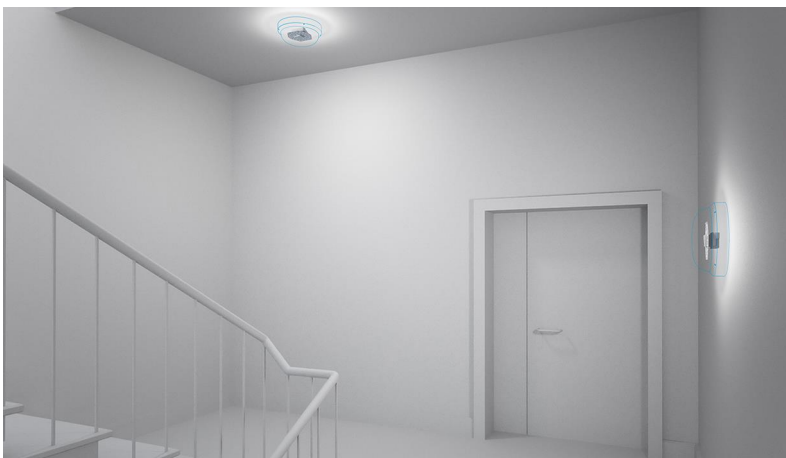

Spotlights



Downlights



Linear



Area



Floor | Wall



Free-standing



Street



Decorative



High bay

Driver LC 17W 250-400mA flexC SC SNC4

essence series

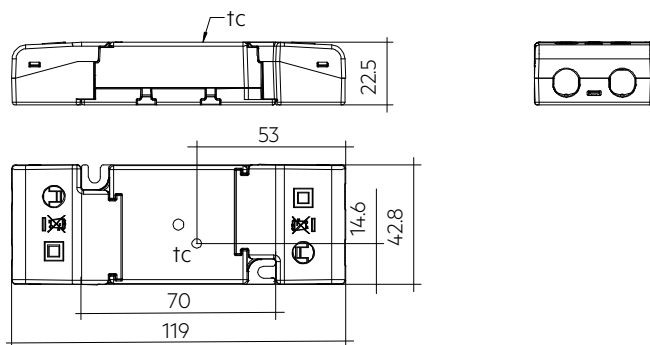
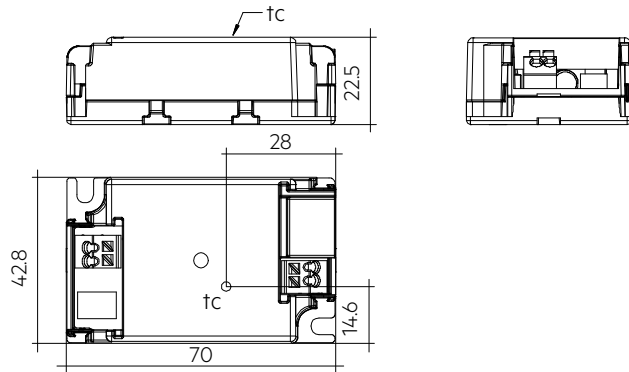

Ordering data

Type	Article number	Packaging, carton	Packaging, pallet	Packaging, high volume	Weight per pc.
LC 17/250-400/42 flexC SC SNC4	87501082	50 pc(s).	1,300 pc(s).	7,800 pc(s).	0.047 kg

Technical data

Rated supply voltage	220 – 240 V
AC voltage range	198 – 264 V
Max. input current (at 230 V, 50 Hz, full load)	0.088 A
Mains frequency	50 / 60 Hz
Overvoltage protection	320 V AC, 2 h
Typ. power consumption (at 230 V, 50 Hz, full load) ^①	19.5 W
Min. output power	6 W
Max. output power	16.8 W
Typ. efficiency (at 230 V, 50 Hz, full load) ^①	85.5 %
λ over full operating range (max.) ^①	0.97
λ over full operating range (min.)	0.86C
Output current tolerance ^②	± 7.5 %
Max. output current peak ^③	≤ output current + 12 %
Max. output voltage (U-OUT)	55 V
THD (at 230 V, 50 Hz, full load) ^①	< 15 %
Output LF current ripple (< 120 Hz)	± 5 %
Output P_ST_LM (at full load)	≤ 1
Output SVM (at full load)	≤ 0.4
Starting time (at 230 V, 50 Hz, full load)	≤ 0.5 s
Turn off time (at 230 V, 50 Hz, full load)	≤ 0.5 s
Hold on time at power failure (output)	0 s
Ambient temperature t_a (at lifetime 50,000 h)	50 °C
Storage temperature t_s	-40 ... +80 °C
Mains burst capability	1 kV
Mains surge capability (between L - N)	1 kV
Mains surge capability (between L/N - PE)	2 kV
Surge voltage at output side (against PE)	3 kV
Lifetime	up to 100,000 h
Guarantee (conditions at www.tridonic.com)	5 Year(s)
Dimensions L x W x H	70 x 43 x 22.5 mm

Approval marks**Standards**

EN 55015, EN 61000-3-2, EN 61000-3-3, EN 61347-1, EN 61347-2-13, EN 61547, EN 62384

Specific technical data

Type	Output current ^④	Min. output voltage	Max. output voltage	Max. output power	Typ. power consumption (at 230 V, 50 Hz, full load)	Typ. current consumption (at 230 V, 50 Hz, full load)	Efficiency (at 230 V, 50 Hz, full load)	t_c point max ^④	Ambient temperature t_a	I-out select
LC 17/250-400/42 flexC SC SNC4	250 mA	24 V	42 V	10.5 W	12.5 W	58 mA	83.0 %	75 °C	-20 ... +50 °C	1=off / 2=off
LC 17/250-400/42 flexC SC SNC4	300 mA	24 V	42 V	12.6 W	15.0 W	68 mA	83.5 %	75 °C	-20 ... +50 °C	1=on / 2=off
LC 17/250-400/42 flexC SC SNC4	350 mA	24 V	42 V	14.7 W	17.5 W	80 mA	84.5 %	80 °C	-20 ... +50 °C	1=off / 2=on
LC 17/250-400/42 flexC SC SNC4	400 mA	24 V	42 V	16.8 W	19.5 W	88 mA	85.5 %	80 °C	-20 ... +50 °C	1=on / 2=on

① Test result at 400 mA.

② Output current is mean value.

③ Test result at 25 °C.

④ Values for built-in application. For independent application t_a max + 40 °C, t_c values see data sheet 2.1 Expected life-time.

Strain-relief set 43x22.5mm

Accessory



Product description

- _ Optional strain-relief set for independent applications
- _ Easy and tool-free mounting to the LED driver
- _ Screwless cable-clamp channels
- _ Transforms the LED driver into a fully class II compatible LED driver (e.g. ceiling installation)
- _ Use each strain relief channel for one cable only
- _ Overall length = length L (LED driver) + 2 x 24.5 mm (strain-relief set)
- _ A carton of 10 pcs. is equal to 10 sets, each with 2 strain-reliefs parts

Website

<http://www.tridonic.com/28001534>

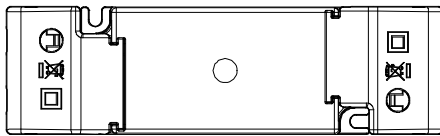
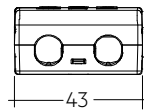
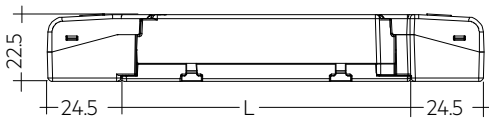

Permissible
cable jacket
diameter:
2.2 – 9 mm

Ordering data

Type	Article number	Packaging, carton	Packaging, outer box	Weight per pc.
ACU SC 43x22.5mm CLIP-ON SR SET	28001534	10 pc(s).	200 pc(s).	0.027 kg

Approval marks



1. Standards

EN 55015
 EN 61000-3-2
 EN 61000-3-3
 EN 61347-1
 EN 61347-2-13
 EN 61547
 EN 62384

1.1 Glow-wire test

according to EN 61347-1 with increased temperature of 850 °C passed.

2. Thermal details and lifetime

2.1 Expected lifetime

Expected lifetime for build-in use

Type	Output current	ta	30 °C	40 °C	50 °C
LC 17/250-400/42 flexC SC SNC4	250 mA	tc	55 °C	65 °C	75 °C
		Lifetime	100,000 h	100,000 h	>80,000 h
	300 mA	tc	55 °C	65 °C	75 °C
		Lifetime	100,000 h	100,000 h	>80,000 h
	350 mA	tc	60 °C	70 °C	80 °C
		Lifetime	100,000 h	100,000 h	>55,000 h
	400 mA	tc	60 °C	70 °C	80 °C
		Lifetime	100,000 h	100,000 h	>55,000 h

Expected lifetime for independent use

Type	Output current	ta	25 °C	30 °C	40 °C
LC 17/250-400/42 flexC SC SNC4	250 mA	tc	55 °C	60 °C	70 °C
		Lifetime	100,000 h	100,000 h	70,000 h
	300 mA	tc	55 °C	60 °C	70 °C
		Lifetime	100,000 h	100,000 h	70,000 h
	350 mA	tc	60 °C	65 °C	75 °C
		Lifetime	100,000 h	100,000 h	50,000 h
	400 mA	tc	60 °C	65 °C	75 °C
		Lifetime	100,000 h	100,000 h	50,000 h

The LED drivers are designed for a lifetime stated above under reference conditions and with a failure probability of less than 10 %.

The relation of tc to ta temperature depends also on the luminaire design. If the measured tc temperature is approx. 5 K below tc max., ta temperature should be checked and eventually critical components (e.g. ELCAP) measured. Detailed information on request.

3. Installation / wiring

3.1 Circuit diagram

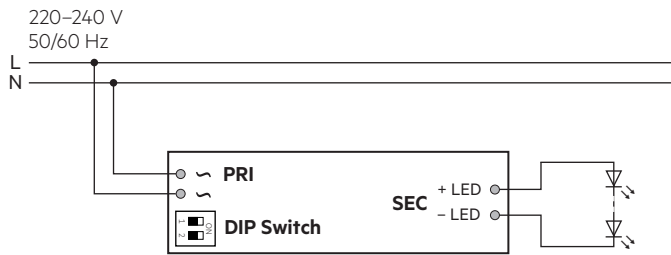

3.2 Wiring type and cross section for input

For wiring use stranded wire with ferrules or solid wire from 0.5–1.5 mm². Strip 8.5–9.5 mm of insulation from the cables to ensure perfect operation of the push-wire terminals. Use one wire for each terminal connector only.

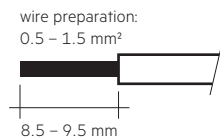

3.3 Release of the wiring

Press down the “push button” and remove the cable from front.

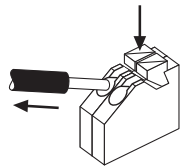

3.4 Fixing conditions when using as independent Driver with Clip-On

Dry, acidfree, oilfree, fatfree. It is not allowed to exceed the maximum ambient temperature (t_a) stated on the device. Minimum distances stated below are recommendations and depend on the actual luminaire. Is not suitable for fixing in corner.

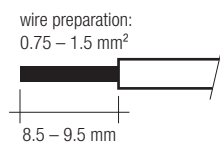
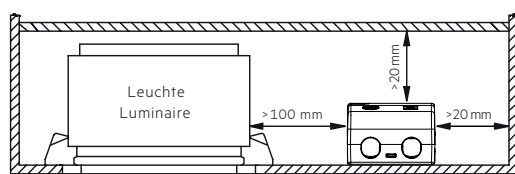

3.5 Wiring type and cross section for output

For wiring use stranded wire with ferrules or solid wire from 0.2–1.5 mm². Strip 8.5–9.5 mm of insulation from the cables to ensure perfect operation of the push-wire terminals. Use one wire for each terminal connector only.

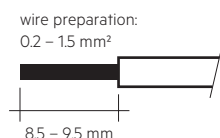

3.6 Wiring guidelines

- All connections must be kept as short as possible to ensure good EMI behaviour.
- Mains leads should be kept apart from LED driver and other leads (ideally 5 – 10 cm distance)
- Max. length of output wires is 2 m.
- To comply with the EMC regulations run the secondary wires (LED module) in parallel.
- Secondary switching is not permitted.
- Incorrect wiring can damage LED modules.
- To avoid the damage of the Driver, the wiring must be protected against short circuits to earth (sharp edged metal parts, metal cable clips, louver, etc.).

3.7 Replace LED module

1. Mains off
2. Remove LED module
3. Wait for 20 seconds
4. Connect LED module again

Hot plug-in or secondary switching of LEDs is not permitted and may cause a very high current to the LEDs.

3.8 Installation instructions

The LED module and all contact points within the wiring must be sufficiently insulated against 3 kV surge voltage.

Air and creepage distance must be maintained.

3.9 Current setting



Set the current by DIP switch after mains off.
Use of DIP switch only after mains off.

250 mA: Switch 1 = Off, Switch 2 = Off

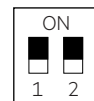

300 mA: Switch 1 = On, Switch 2 = Off



350 mA: Switch 1 = Off, Switch 2 = On



400 mA: Switch 1 = On, Switch 2 = On



3.10 Mounting of device

Max. torque for fixing: 0.5 Nm/M4

4. Electrical values

4.1 Efficiency vs load

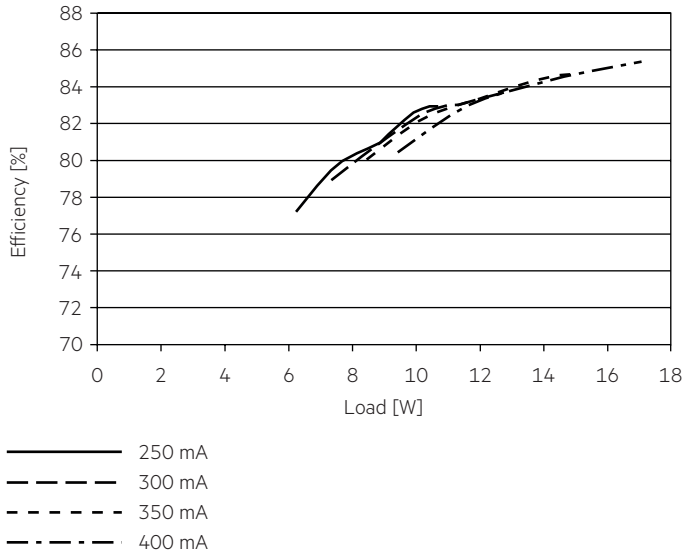

4.2 Power factor vs load

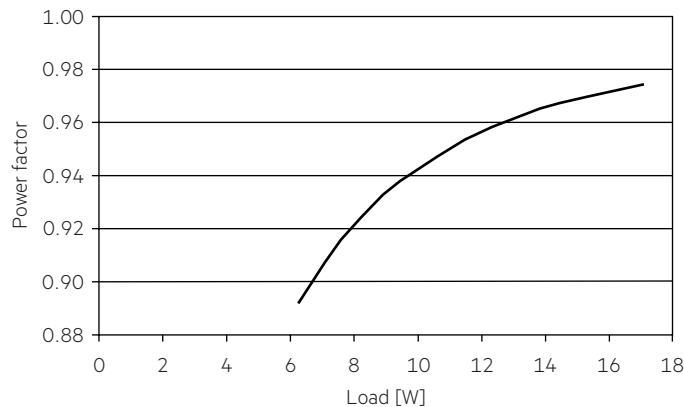

4.3 THD vs load

THD without harmonic < 5 mA (0.6 %) of the input current:

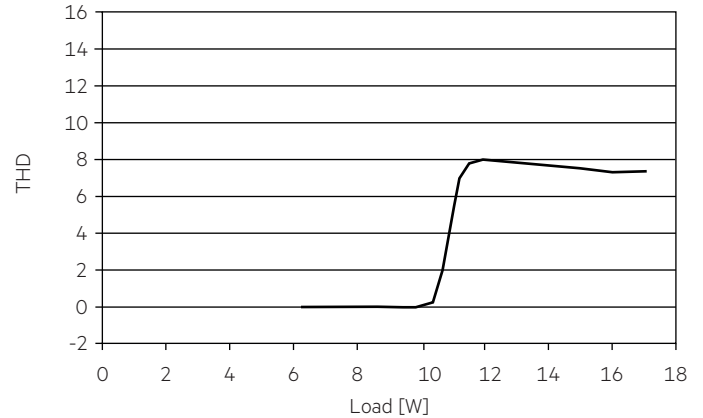

4.6 Maximum loading of automatic circuit breakers in relation to inrush current

Automatic circuit breaker type	C10	C13	C16	C20	B10	B13	B16	B20	Inrush current
Installation Ø	1.5 mm ²	1.5 mm ²	1.5 mm ²	2.5 mm ²	1.5 mm ²	1.5 mm ²	1.5 mm ²	2.5 mm ²	I _{max} Time
LC 17/250-400/42 flexC SC SNC4	72	94	116	145	72	94	116	145	3.5 A 35 µs

These are max. values calculated out of continuous current running the device on full load.

There is no limitation due to inrush current.

If load is smaller than full load for calculation only continuous current has to be considered.

4.7 Harmonic distortion in the mains supply (at 230 V / 50 Hz and full load) in %

	THD	3.	5.	7.	9.	11.
LC 17/250-400/42 flexC SC SNC4	< 15	< 12	< 8	< 5	< 5	< 3

Acc. to 61000-3-2. Harmonics < 5 mA or < 0.6 % (whatever is greater) of the input current are not considered for calculation of THD.

5. Functions

5.1 Short-circuit behaviour

In case of a short circuit on the secondary side (LED) the LED driver switches off. After elimination of the short-circuit fault the LED driver will recover automatically.

5.2 No-load operation

The LED driver works in burst working mode to provide a constant output voltage regulation which allows the application to be able to work safely when LED string opens due to a failure.

5.3 Overload protection

If the maximum load is exceeded by a defined internal limit, the LED driver will protect itself and LED may flicker. After elimination of the overload the nominal operation will recover automatically.

5.4 Overtemperature protection

The LED driver is protected against temporary thermal overheating. If the temperature limit is exceeded, the output current will reduce or LED may flicker. It will recover automatically.

6. Miscellaneous

6.1 Disposal of equipment



Return old devices in accordance with the WEEE directive to suitable recycling facilities.

6.2 Insulation and electric strength testing of luminaires

Electronic devices can be damaged by high voltage. This has to be considered during the routine testing of the luminaires in production.

According to IEC 60598-1 Annex Q (informative only!) or ENEC 303-Annex A, each luminaire should be submitted to an insulation test with 500 V_{DC} for 1 second. This test voltage should be connected between the interconnected phase and neutral terminals and the earth terminal. The insulation resistance must be at least 2 MΩ.

As an alternative, IEC 60598-1 Annex Q describes a test of the electrical strength with 1500 V_{AC} (or 1.414 x 1500 V_{DC}). To avoid damage to the electronic devices this test must not be conducted.

6.3 Conditions of use and storage

Humidity: 5% up to max. 85%,
not condensed
(max. 56 days/year at 85%)

Storage temperature: -40 °C up to max. +80 °C

The devices have to be within the specified temperature range (t_a) before they can be operated.

6.4 Maximum number of switching cycles

All LED driver are tested with 50,000 switching cycles.

6.5 Additional information

Additional technical information at www.tridonic.com → Technical Data

Lifetime declarations are informative and represent no warranty claim. No warranty if device was opened.