

Driver LCA 21W 300-500mA flexC PH-C SR ADV

advanced series

**Product description**

- _ Dimmable constant current LED driver (SELV)
- _ Independent LED driver with cable clamps
- _ Dimmable via leading edge and trailing edge phase dimmers
- _ Dimming range 5 to 100 % (depending on dimmer)
- _ For luminaires of protection class I and protection class II
- _ For luminaires with M and MM as per EN 60598, VDE 0710 and VDE 0711
- _ Temperature protection as per EN 61347-2-13 C5e
- _ Selectable output current between 300, 450 and 500 mA
- _ Max. output power 21 W
- _ Up to 82 % efficiency
- _ Nominal lifetime up to 50,000 h
- _ 5 years guarantee (conditions at <https://www.tridonic.com/manufacturer-guarantee-conditions>)

Housing properties

- _ Casing: polycarbonate, white
- _ Type of protection IP20

Interfaces

- _ Terminal blocks: 0° screw terminals

Functions

- _ Overload protection
- _ Short-circuit protection
- _ No-load protection
- _ Overtemperature protection
- _ Burst protection voltage 1 kV
- _ Surge protection voltage 1 kV (L to N)
- _ Surge protection voltage 2 kV (L/N to earth)

Website

<http://www.tridonic.com/87500603>



Spotlights



Downlights



Linear



Area



Floor | Wall



Free-standing



Street



Decorative



High bay

Driver LCA 21W 300-500mA flexC PH-C SR ADV

advanced series

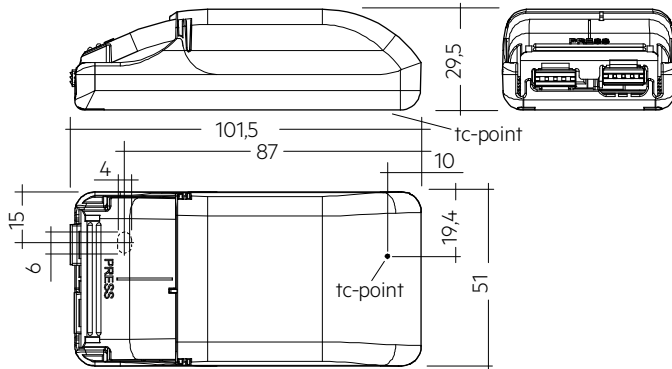

Ordering data

Type	Article number	Packaging, carton	Packaging, low volume	Packaging, high volume	Weight per pc.
LCA 21W 300-500mA flexC PH-C SR ADV	87500603	50 pc(s).	700 pc(s).	3,500 pc(s).	0.093 kg

Technical data

Rated supply voltage	220 – 240 V
AC voltage range	198 – 264 V
Max. input current (at 230 V, 50 Hz, full load)	0.11 A
Leakage current (at 230 V, 50 Hz, full load)	< 500 μ A
Mains frequency	50 Hz
Overvoltage protection	320 V AC, 1 h
Max. input power ^①	26 W
Typ. power consumption (at 230 V, 50 Hz, full load) ^①	25 W
Min. output power	8.4 W
Max. output power	21 W
Typ. efficiency (at 230 V, 50 Hz, full load) ^①	82 %
λ (at 230 V, 50 Hz, full load) ^①	0.95
Output current tolerance ^{②③}	\pm 7.5 %
Max. output current peak ^③	\leq output current + 40 %
Max. output voltage (U-OUT)	60 V
THD (at 230 V, 50 Hz, full load)	< 10 %
Output LF current ripple (< 120 Hz)	\pm 30 %
Starting time (at 230 V, 50 Hz, full load)	\leq 0.5 s
Turn off time (at 230 V, 50 Hz, full load)	\leq 0.5 s
Hold on time at power failure (output)	0 s
Ambient temperature t_a (at lifetime 50,000 h)	40 °C
Storage temperature t_s	-40 ... +80 °C
Lifetime	up to 50,000 h
Guarantee (conditions at www.tridonic.com)	5 Year(s)
Dimensions L x W x H	101.5 x 51 x 29.5 mm

Approval marks



Standards

EN 55015, EN 60598-1, EN 61000-3-2, EN 61000-3-3, EN 61347-1, EN 61347-2-13, EN 61547, EN 62384

Specific technical data

Type	Output current ^②	Min. output voltage	Max. output voltage	Max. output power	Typ. power consumption (at 230 V, 50 Hz, full load)	Typ. current consumption (at 230 V, 50 Hz, full load)	tc point max.	Ambient temperature ta	I-out select
LCA 21W 300-500mA flexC PH-C SR ADV	300 mA	28 V	42 V	12.6 W	15.0 W	67 mA	90 °C	-20 ... +50 °C	+LED / -300mA
LCA 21W 300-500mA flexC PH-C SR ADV	450 mA	28 V	42 V	18.9 W	22.5 W	100 mA	90 °C	-20 ... +50 °C	+LED / -450mA
LCA 21W 300-500mA flexC PH-C SR ADV	500 mA	28 V	42 V	21.0 W	25.0 W	110 mA	90 °C	-20 ... +50 °C	+LED / -500mA

① Test result at 500 mA.

② Output current is mean value.

③ Test result at 25 °C.

1. Standards

EN 55015
 EN 60598-1
 EN 61000-3-2
 EN 61000-3-3
 EN 61347-1
 EN 61347-2-13
 EN 61547
 EN 62384

1.1 Glow wire test

according to EN 61347-1 with increased temperature of 850 °C passed.

2. Thermal details and lifetime

2.1 Expected lifetime

Expected lifetime				
Type	Current	t_a	40 °C	50 °C
LCA 21W 300-500mA flexC PH-C SR ADV	300 mA	t_c	80 °C	90 °C
		Lifetime	50,000 h	30,000 h
	450 mA	t_c	80 °C	90 °C
		Lifetime	50,000 h	30,000 h
500 mA	t_c	80 °C	90 °C	
	Lifetime	50,000 h	30,000 h	

The LED driver is designed for a lifetime stated above under reference conditions and with a failure probability of less than 10 %.

The relation of t_c to t_a temperature depends also on the luminaire design. If the measured t_c temperature is approx. 5 K below t_c max., t_a temperature should be checked and eventually critical components (e.g. ELCAP) measured. Detailed information on request.

3. Installation / wiring

3.1 Circuit diagram

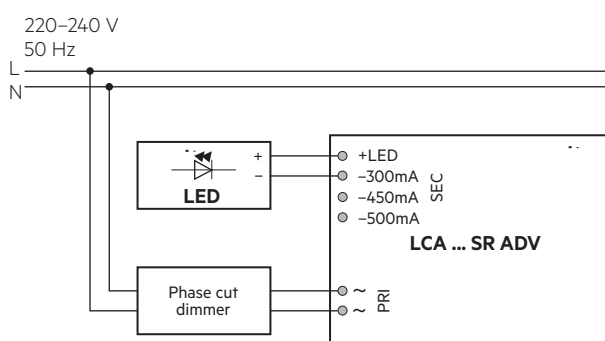

3.2 Wiring type and cross section

For wiring use stranded wire with ferrules or solid wire. For perfect function of the cage clamp terminals the strip length should be 4 – 5 mm for the input terminal. The max. torque at the clamping screw (M3) is 0.2 Nm.

Input terminal (D2)

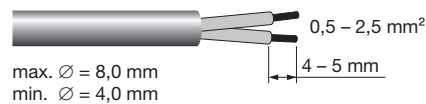

Output terminal (D1)

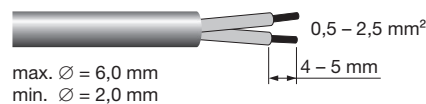

To get a proper working strain relief it is recommended that the cable jacket diameter of the side D2 is 2 mm bigger than the diameter of the side D1. (This can vary if the used cable jacket material varies from side D2 to D1 in pinching property).

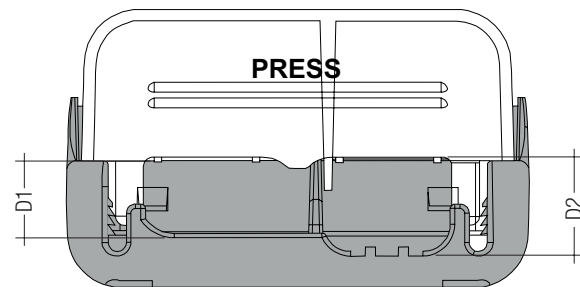

Depending on the used flaps of the terminal following cable jacket diameter difference between the side D2 and D1 terminals is recommended:

Side D1		Side D2		Difference D2 - D1		
Housing bottom	Cover terminal	With flap	Without flap			
With flap	Without flap	With flap	Without flap	With flap	Without flap	
x	-	x	-	x	-	3.5 mm
x	-	x	-	-	x	5.5 mm
x	-	-	x	-	x	3.5 mm
-	x	x	-	-	x	3.5 mm
-	x	-	x	-	x	1.5 mm
x	-	-	x	x	-	1.5 mm
-	x	x	-	x	-	1.5 mm
-	x	-	x	x	-	-0.5 mm

3.3 Fixing conditions

Dry, acidfree, oilfree, fatfree. It is not allowed to exceed the maximum ambient temperature (t_a) stated on the device. Minimum distances stated below are recommendations and depend on the actual luminaire. Is not suitable for fixing in corner.

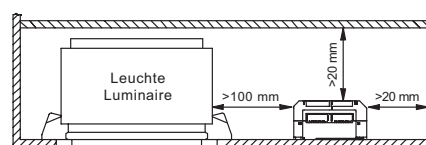

The LED module and all contact points within the wiring must be sufficiently insulated against 3 kV surge voltage.

3.4 Wiring guidelines

- All connections must be kept as short as possible to ensure good EMI behaviour.
- Mains leads should be kept apart from LED driver and other leads (ideally 5 – 10 cm distance)
- Max. length of output wires is 2 m.
- To comply with the EMC regulations run the secondary wires (LED module) in parallel.
- Through wiring is not possible.
- Incorrect wiring can damage LED modules.
- To avoid the damage of the Driver, the wiring must be protected against short circuits to earth (sharp edged metal parts, metal cable clips, louver, etc.).
- The current selection has to be installed in the accordance to the requirement of low voltage installation.

3.5 Replace LED module

1. Mains off
2. Remove LED module
3. Wait for 20 seconds
4. Connect LED module again

Hot plug-in or output switching of LEDs is not permitted and may cause a very high current to the LEDs.

3.6 Current select

For 300 mA current use this terminals:

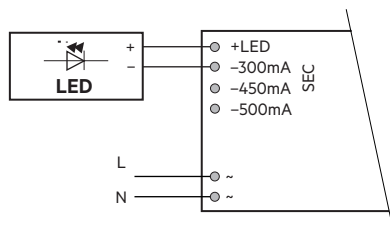

For 450 mA current use this terminals:

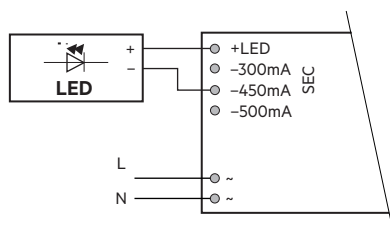

For 500 mA current use this terminals:

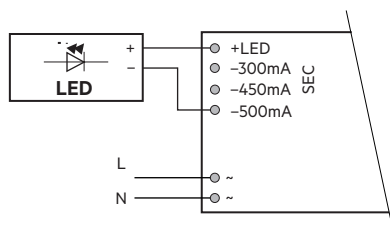

3.7 Mounting of device

Max. torque for fixing: 0.5 Nm/M4

4. Electrical values

Test at 230 V 50 Hz.

4.1 Efficiency vs load

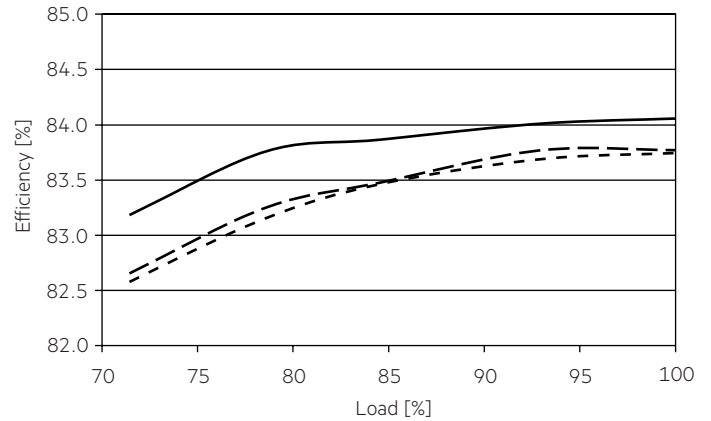

4.2 Power factor vs load

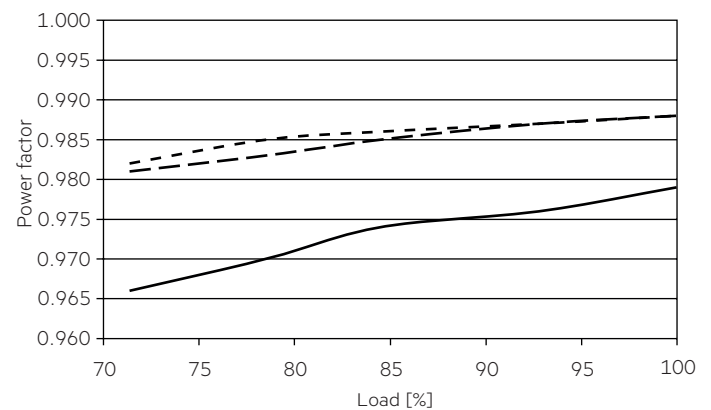

4.3 Input power vs load

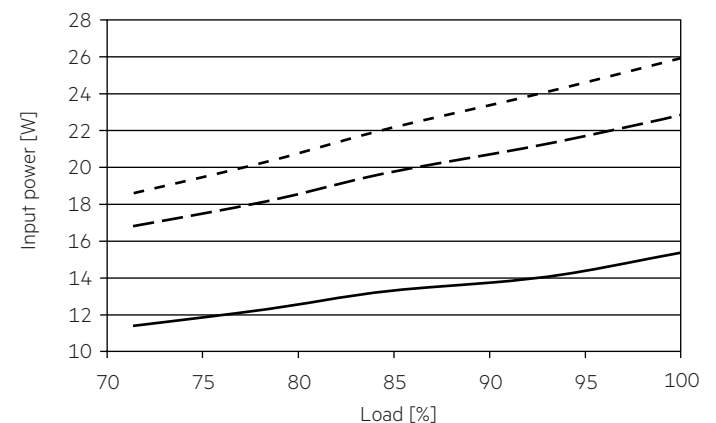

4.4 Input current vs load

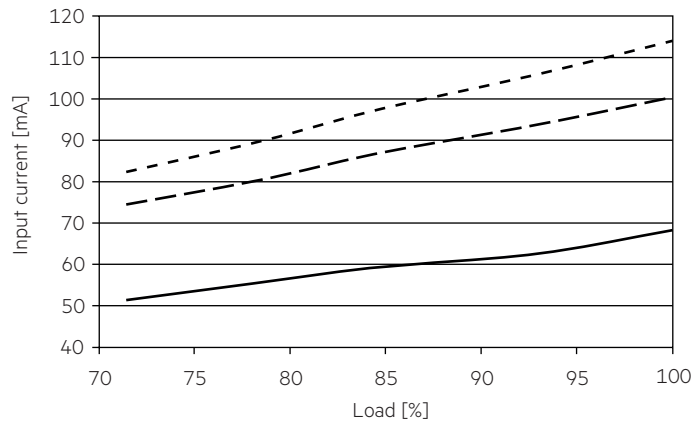

4.5 THD vs load

THD without harmonic < 5 mA (0.6 %):

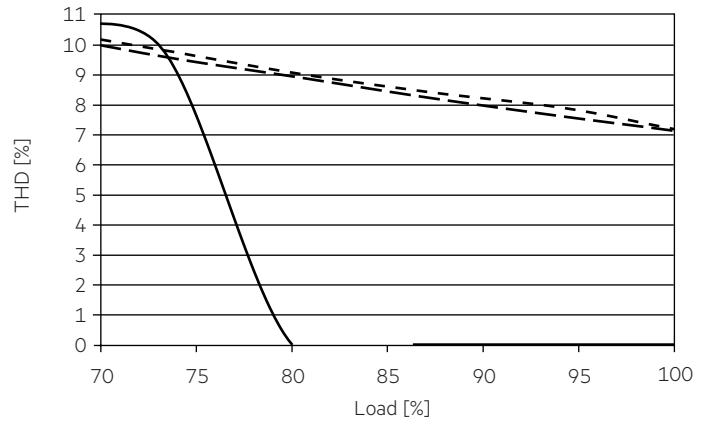

4.6 I_{out} vs V_{in}

At full load:

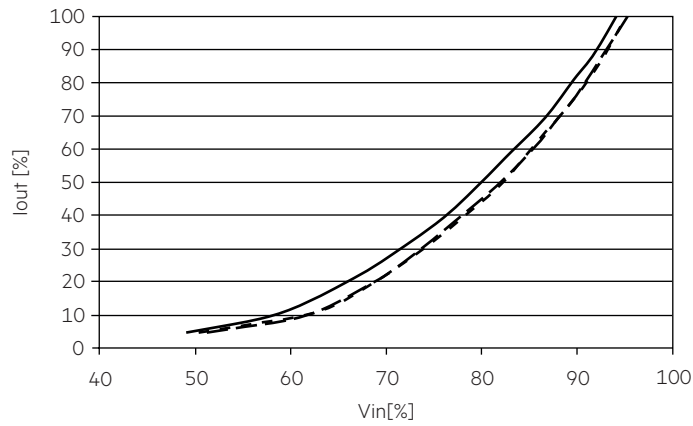

At min. load:

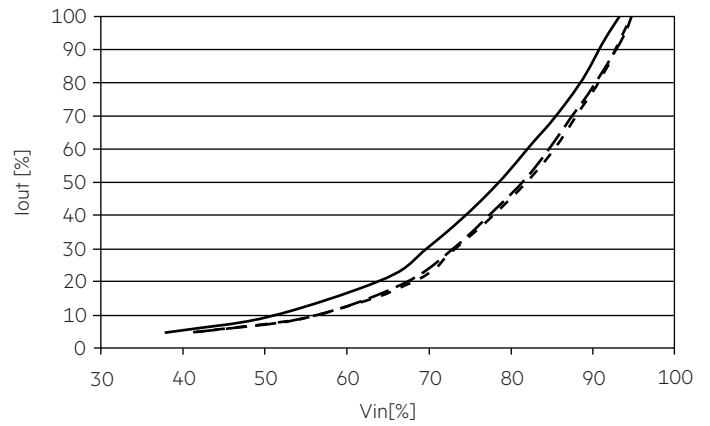

Remark: Dimming curve based on DIMMER ELKO 315GLE!

- 300 mA
- - - 450 mA
- . - . 500 mA

4.7 Maximum loading of automatic circuit breakers in relation to inrush current

Automatic circuit breaker type	C10	C13	C16	C20	B10	B13	B16	B20	Inrush current
Installation Ø	1.5 mm ²	1.5 mm ²	1.5 mm ²	2.5 mm ²	1.5 mm ²	1.5 mm ²	1.5 mm ²	2.5 mm ²	I _{max} Time
LCA 21W 300-500mA flexC PH-C SR ADV	58	75	93	116	58	75	93	116	6 A 80 µs

These are max. values calculated out of inrush current! Please consider not to exceed the maximum rated continuous current of the circuit breaker. Calculation uses typical values from ABB series S200 as a reference. Actual values may differ due to used circuit breaker types and installation environment.

4.8 Harmonic distortion in the mains supply (at 230 V / 50 Hz and full load) in %

	THD	3.	5.	7.	9.	11.
LCA 21W 300-500mA flexC PH-C SR ADV	< 10	< 8	< 5	< 5	< 4	< 3

Acc. to 6100-3-2. Harmonics < 5 mA or < 0.6 % (whatever is greater) of the input current are not considered for calculation of THD.

5. Functions

5.1 Short-circuit behaviour

In case of a short circuit on the output side (LED) the LED driver protects itself. After elimination of the short-circuit fault the LED driver will recover automatically.

5.2 No-load operation

In no-load operation the output voltage will not exceed the specified max. output voltage.

5.3 Overload protection

If the maximum load is exceeded by a defined internal limit, the LED driver will protect itself and LED may flicker. After elimination of the overload, the nominal operation is restored automatically.

5.4 Over temperature protection

The LED driver is protected against temporary thermal overheating. If the temperature limit is exceeded the output current is reduced to limit t_c at a certain level.

6. Miscellaneous

6.1 Insulation and electric strength testing of luminaires

Electronic devices can be damaged by high voltage. This has to be considered during the routine testing of the luminaires in production.

According to IEC 60598-1 Annex Q (informative only!) or ENEC 303-Annex A, each luminaire should be submitted to an insulation test with 500 V_{DC} for 1 second. This test voltage should be connected between the interconnected phase and neutral terminals and the earth terminal. The insulation resistance must be at least 2 M Ω .

As an alternative, IEC 60598-1 Annex Q describes a test of the electrical strength with 1500 V_{AC} (or 1.414 x 1500 V_{DC}). To avoid damage to the electronic devices this test must not be conducted.

6.2 Conditions of use and storage

Humidity: 5 % up to max. 85 %,
not condensed
(max. 56 days/year at 85 %)

Storage temperature: -40 °C up to max. +80 °C

The devices have to be within the specified temperature range (t_a) before they can be operated.

6.3 Maximum number of switching cycles

All LED driver are tested with 50,000 switching cycles.

6.4 Additional information

Additional technical information at www.tridonic.com → Technical Data

Lifetime declarations are informative and represent no warranty claim. No warranty if device was opened.